

**RoHS compliant**

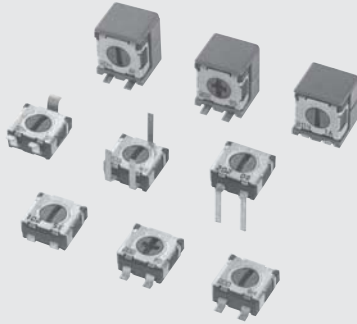

**INTERNAL STRUCTURE**

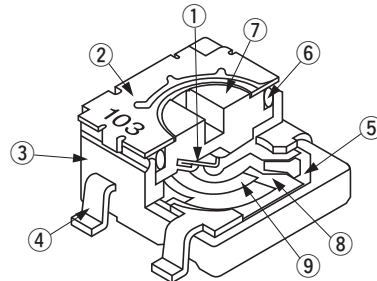

Part name	Material
① Wiper	Multi metal alloy
② Cover	Stainless steel (SUS 304)
③ Housing	Epoxy
④ Terminal pin	Copper alloy, Sn-Cu-plated
⑤ Base element	Ceramic
⑥ "O" ring	Silicone rubber
⑦ Rotor	Polyphenylenesulphide
⑧ Electrode	Ag-Pd cermet
⑨ Resistive element	RuO <sub>2</sub> cermet

**FEATURES**

- RoHS compliant
- Wide variety (7 types) to choose from
- Automatic mounting is possible (Taping)
- Flow/reflow soldering is possible
- Sealed construction (Washable: Refer to page 698.)
- Stopper structure prevents terminal pin from being open.
- Cross slot rotor suitable for automatic adjustment
- Resin materials are UL Recognized 94V-0 or 94V-1 equivalent

**PART NUMBER DESIGNATION**

**S T - 4 E T A 2 0 0 Ω ( 2 0 1 )**

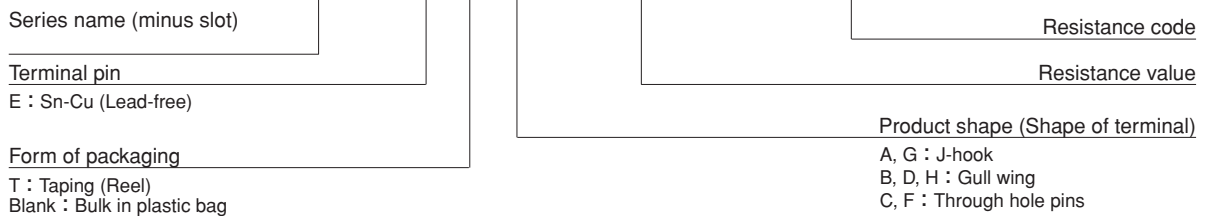

**S T - 4 2 E T A 2 0 0 Ω ( 2 0 1 )**

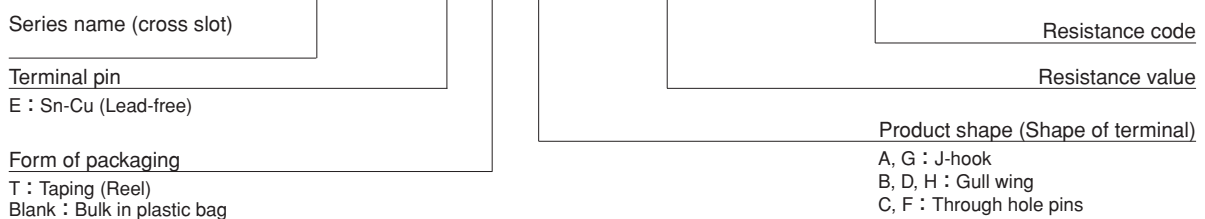

※ Please refer to the LIST OF PART NUMBERS when placing orders.

# ST-4

## SURFACE MOUNT TRIMMERS

### LIST OF PART NUMBERS

Adjustment position	Shape of terminal	Form of packaging	
		Taping (reel)	Plastic bag
Top adjustment	A ( J-hook )	ST-4/42ETA	ST-4/42EA
	B ( Gull wing )	ST-4/42ETB	ST-4/42EB
	C ( Through hole pins )		ST-4/42EC
Rear adjustment	D ( Gull wing )	↻ ST-4/42ETD	↻ ST-4/42ED
	F ( Through hole pins )		↻ ST-4/42EF
Side adjustment	G ( J-hook )	ST-4/42ETG	ST-4/42EG
	H ( Gull wing )	ST-4/42ETH	ST-4/42EH
Pieces in package		500 pcs./reel	100 pcs./pack

The products indicated by ↻ mark are manufactured upon receipt of order basis.  
 ※ ⊖ slot : ST-4E□, ⊕ slot : ST-42E□

### ELECTRICAL CHARACTERISTICS

Nominal resistance range	10 Ω ~ 2 M Ω
Resistance tolerance	± 20 %
Power ratings	0.25 W (70 °C) 0 W (125 °C)
Resistance law	Linear law (B)
Maximum input voltage	DC200 V or power rating, whichever is smaller
Maximum wiper current	100 mA or power rating, whichever is smaller
Effective electrical angle	210° (1 turn)
End resistance	1 % or 2 Ω, whichever is greater
C.R.V.	1 % or 3 Ω, whichever is greater
Operating temp. range	- 55 ~ 125 °C
Temp. coefficient	10 Ω ~ 50 Ω : ± 250 10 <sup>-6</sup> /°C maximum 100 Ω ~ 2 M Ω : ± 100 10 <sup>-6</sup> /°C maximum
Insulation resistance	1000 M Ω minimum (DC500 V)
Dielectric strength	AC500 V, 60 s
Net weight	Approx. 0.12 g (ST-4EA, EB, EC, ED, EF) Approx. 0.22 g (ST-4EG, EH)

### Reflow profile for soldering heat evaluation

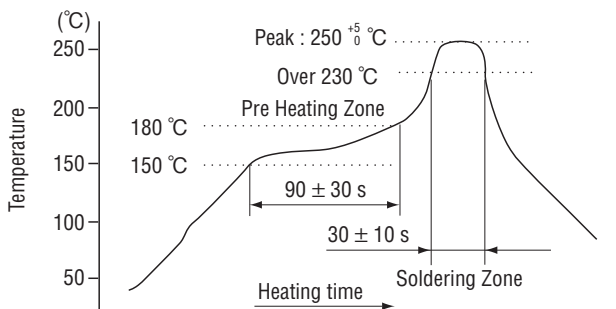

Reflow : two times maximum

### Nominal resistance values

↻10 Ω	↻20 Ω	50 Ω	100 Ω	200 Ω	500 Ω	1 k Ω	2 k Ω	5 k Ω
10 k Ω	20 k Ω	50 k Ω	100 k Ω	200 k Ω	500 k Ω	1 M Ω	2 M Ω	

Fig. 1

↻ : Not manufactured

※ The above part numbers are all available with the respective combination of <Nominal resistance values> (Fig. 1).

※ Verify the above part numbers when placing orders.

※ Taping specification is not sold separately and must be purchased in reel units.

※ Cross slot available : ST-42E □

### MECHANICAL CHARACTERISTICS

Mechanical angle	240° (1 turn)
Operating torque	10 mN·m {102 gf·cm} maximum
Stop strength	30 mN·m {306 gf·cm} minimum
Rotational life	100 cycles [ Δ R/R ≤ ± (2 Ω + 3 %)]
Thrust to rotor	5 N {0.51 kgf} minimum
Solderability	245 ± 3 °C, 2 ~ 3 s
Shear (Adhesion)	5 N {0.51 kgf} 10 s
Substrate bending	Width 90 mm, bend 3 mm, 5 s, 1 time
Pull-off strength	5 N {0.51 kgf} 10 s

{ } : Reference only

### ENVIRONMENTAL CHARACTERISTICS

Test item	Test conditions	Specifications
Thermal shock	- 65 ~ 125 °C (0.5 h), 5 cycles	[ Δ R/R ≤ 2 %] [S.S. ≤ 1 %]
Humidity	- 10 ~ 65 °C (80 ~ 98 %), 10 cycles, 240 h	[ Δ R/R ≤ 2 %]
Shock	981 m/s <sup>2</sup> , 6 ms 6 directions for 3 times each	[ Δ R/R ≤ 1 %] [S.S. ≤ 1 %]
Vibration	(Amplitude) 1.52 mm or (Acceleration) 196 m/s <sup>2</sup> , 10 ~ 2000 Hz, 3 directions, 12 times each	[ Δ R/R ≤ 1 %] [S.S. ≤ 1 %]
Load life	70 °C, 0.25 W 1000 h	[ Δ R/R ≤ 3 %] [S.S. ≤ 1 %]
Low temp. operation	- 55 °C, 2 h	[ Δ R/R ≤ 2 %] [S.S. ≤ 2 %]
High temp. exposure	125 °C, 250 h	[ Δ R/R ≤ 3 %] [S.S. ≤ 2 %]
Immersion seal	85 °C, 60 s	No leaks (No continuous bubbles)
Soldering heat	Flow : 260 ± 3 °C as the temperature in a pot of molten solder, immersion from head of terminal to backside of board, 5 ~ 6 s, two times maximum Reflow : Peak temperature 255 °C (Please refer to the profile below.) Manual soldering : 350 ± 10 °C, 3 ~ 4 s	[ Δ R/R ≤ 1 %]

Δ R/R : Change in total resistance  
 S.S. : Setting stability

### MAXIMUM INPUT RATINGS

Nominal resistance values ( $\Omega$ )	Resistance code	Maximum input voltage (V)	Maximum wiper current (mA)
<ul style="list-style-type: none"> <li>➔ 10</li> <li>➔ 20</li> <li>50</li> <li>100</li> <li>200</li> <li>500</li> </ul>	<ul style="list-style-type: none"> <li>100</li> <li>200</li> <li>500</li> <li>101</li> <li>201</li> <li>501</li> </ul>	<ul style="list-style-type: none"> <li>1.00</li> <li>2.00</li> <li>3.53</li> <li>5.00</li> <li>7.07</li> <li>11.2</li> </ul>	<ul style="list-style-type: none"> <li>100</li> <li>100</li> <li>70.7</li> <li>50.0</li> <li>35.4</li> <li>22.4</li> </ul>
<ul style="list-style-type: none"> <li>1 k</li> <li>2 k</li> <li>5 k</li> <li>10 k</li> <li>20 k</li> <li>50 k</li> </ul>	<ul style="list-style-type: none"> <li>102</li> <li>202</li> <li>502</li> <li>103</li> <li>203</li> <li>503</li> </ul>	<ul style="list-style-type: none"> <li>15.8</li> <li>22.4</li> <li>35.4</li> <li>50.0</li> <li>70.7</li> <li>112</li> </ul>	<ul style="list-style-type: none"> <li>15.8</li> <li>11.2</li> <li>7.07</li> <li>5.00</li> <li>3.54</li> <li>2.24</li> </ul>
<ul style="list-style-type: none"> <li>100 k</li> <li>200 k</li> <li>500 k</li> <li>1 M</li> <li>2 M</li> </ul>	<ul style="list-style-type: none"> <li>104</li> <li>204</li> <li>504</li> <li>105</li> <li>205</li> </ul>	<ul style="list-style-type: none"> <li>158</li> <li>200</li> <li>200</li> <li>200</li> <li>200</li> </ul>	<ul style="list-style-type: none"> <li>1.58</li> <li>1.00</li> <li>0.40</li> <li>0.20</li> <li>0.10</li> </ul>

The products indicated by ➔ mark are manufactured upon receipt of order basis.

### RECOMMENDED P.C.B. PAD OUTLINE DIMENSIONS

(Unit: mm)

#### ST-4EA

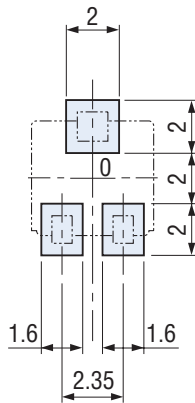

#### ST-4EB

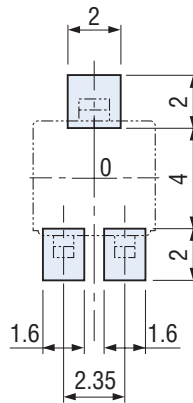

#### ST-4ED

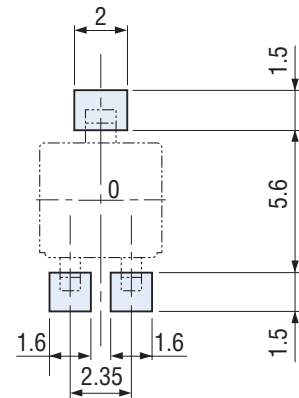

#### ST-4EG

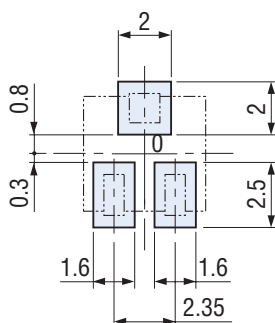

#### ST-4EH

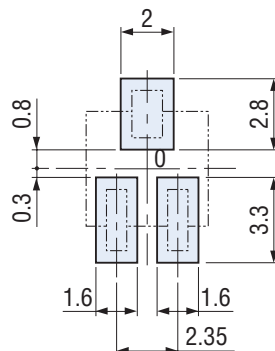

Note) The zero point is the center of mounting.

# ST-4

## SURFACE MOUNT TRIMMERS

### OUTLINE DIMENSIONS

Unless otherwise specified, tolerance :  $\pm 0.3$  (Unit: mm)

#### ST-4EA Top adjustment

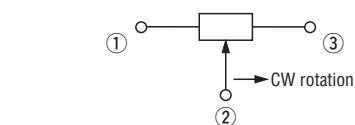
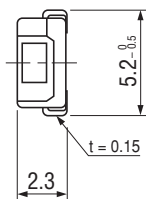
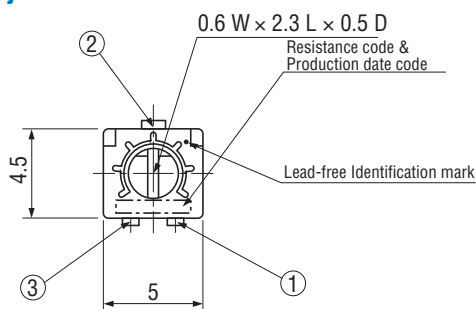

※ Note the terminal position.

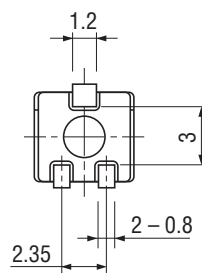

#### ST-4EB Top adjustment

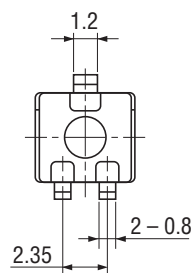
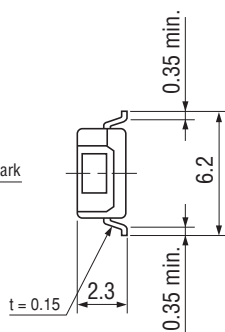
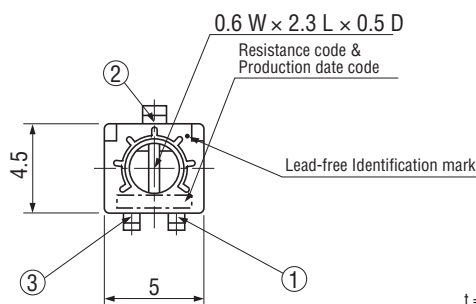

#### ST-4EC Top adjustment

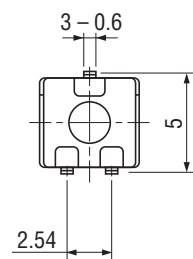
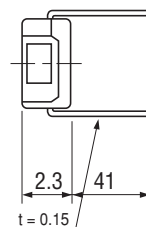
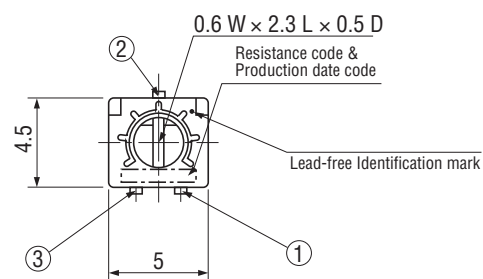

#### ST-4EG Side adjustment

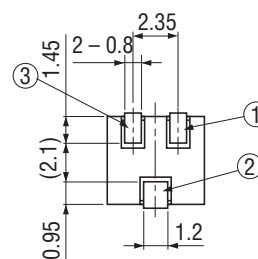
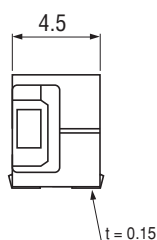
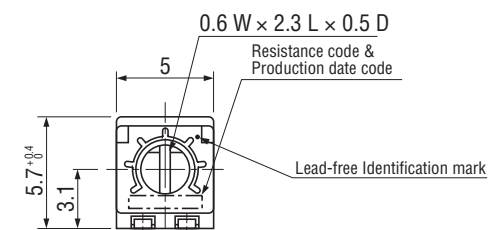

### OUTLINE DIMENSIONS

Unless otherwise specified, tolerance :  $\pm 0.3$  (Unit: mm)

#### ● ST-4EH Side adjustment

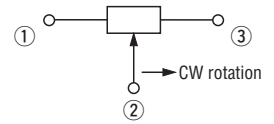
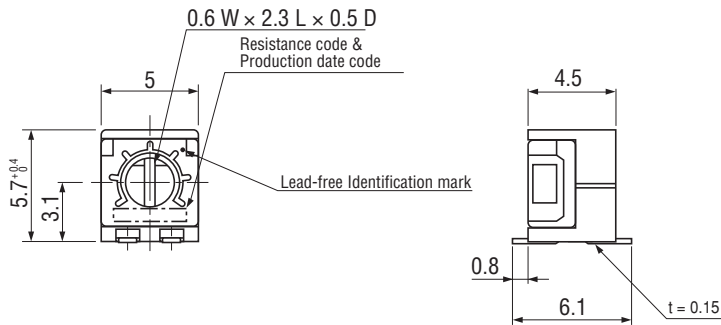

※ Note the terminal position.

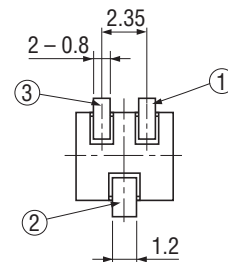

#### ● ST-4ED Rear adjustment

< Semi-standard products >

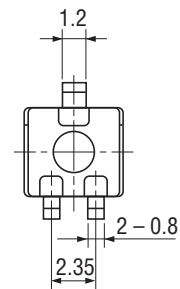
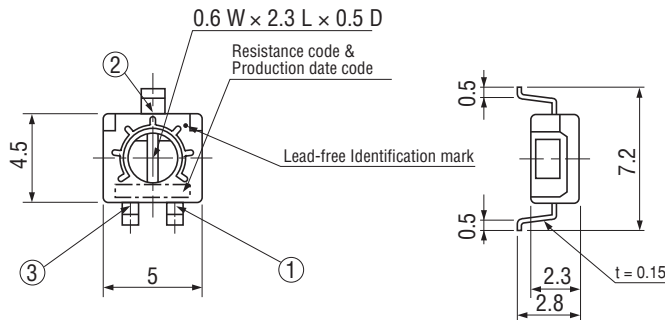

#### ● ST-4EF Rear adjustment

< Semi-standard products >

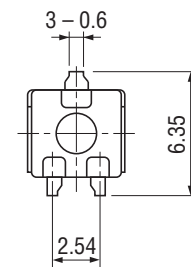
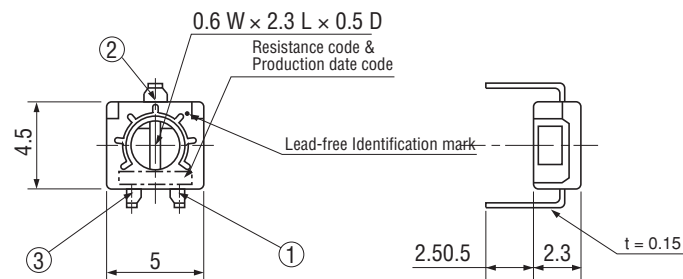

#### ● ST-42E + CROSS SLOT DIMENSION

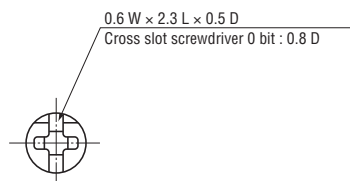

# ST-4

## SURFACE MOUNT TRIMMERS

### PACKAGING SPECIFICATIONS

#### <Taping packaging specifications>

- Taping version is packaged in 500 pcs. per reel.  
Orders will be accepted for units of 500 pcs., i.e., 500, 1000, 1500 pcs., etc.
- ST-4ETA, ETB and ETD versions are boxed with 4 reels (2000 pcs.).  
ST-4ETG and ETH versions are boxed with one reel (500 pcs.).

Maximum number of consecutive missing pieces = 2  
Leader length and reel dimension are shown in the diagrams below.

### EMBOSSED TAPE DIMENSIONS

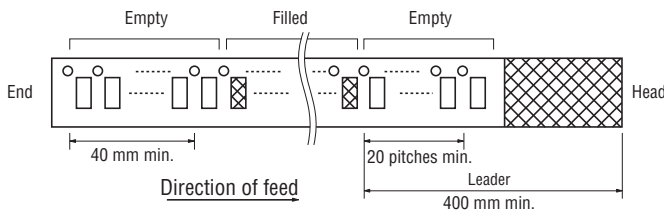

### REEL DIMENSIONS

(Conforms to JIS C 0806-3)

(In accordance with EIAJ ET-7200A)

(Unit: mm)

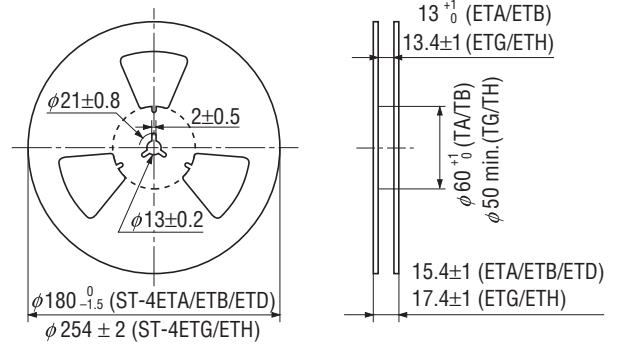

### ST-4ETA/ETB/ETD

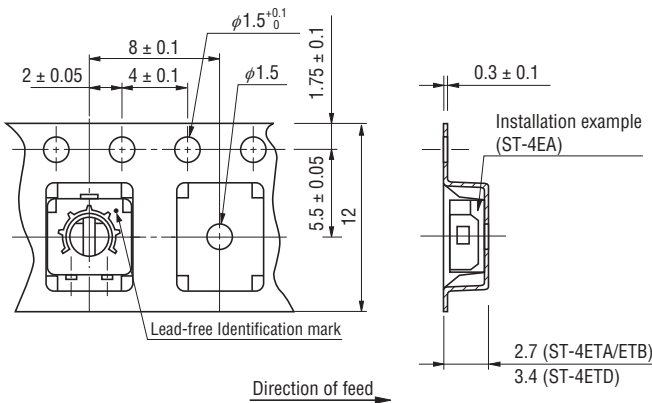

### ST-4ETG/ETH

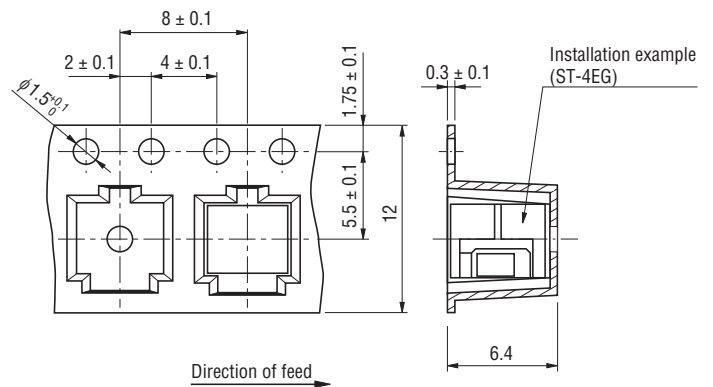

#### <Bulk pack specifications>

- Unit of bulk in a plastic bag is 100 pcs. per pack.
- Boxing of bulk in a plastic bag is performed with 500 pcs. per box.

# Mouser Electronics

Authorized Distributor

Click to View Pricing, Inventory, Delivery & Lifecycle Information:

## Nidec:

[ST-4ETB204](#) [ST-4ETB201](#) [ST-4ETA104](#) [ST-4ETB101](#) [ST-4ETA502](#) [ST-4ETB200](#) [ST-4ETB202](#) [ST-4ETB203](#) [ST-4ETB103](#) [ST-4ETA501](#) [ST-4ETA503](#) [ST-4ETB502](#) [ST-4ETB501](#) [ST-4ETB503](#) [ST-4ETA500](#) [ST-4ETA504](#) [ST-4ETA103](#) [ST-4ETB100](#) [ST-4ETA203](#) [ST-4ETB104](#) [ST-4ETA101](#) [ST-4ETA102](#) [ST-4ETA105](#) [ST-4ETB102](#) [ST-4ETA202](#) [ST-4ETH503](#) [ST-4ETH504](#) [ST-4ETH203](#) [ST-4ETH204](#) [ST-4ETH205](#) [ST-4ETH500](#) [ST-4ETH501](#) [ST-4ETH502](#) [ST-4ETH103](#) [ST-4ETH104](#) [ST-4ETH105](#) [ST-4ETH200](#) [ST-4ETH201](#) [ST-4ETH202](#) [ST-4ETG502](#) [ST-4ETG503](#) [ST-4ETG504](#) [ST-4ETH100](#) [ST-4ETH101](#) [ST-4ETH102](#) [ST-4ETG202](#) [ST-4ETG203](#) [ST-4ETG204](#) [ST-4ETG205](#) [ST-4ETG500](#) [ST-4ETG501](#) [ST-4ETG102](#) [ST-4ETG103](#) [ST-4ETG104](#) [ST-4ETG105](#) [ST-4ETG200](#) [ST-4ETG201](#) [ST-4ETD501](#) [ST-4ETD502](#) [ST-4ETD503](#) [ST-4ETD504](#) [ST-4ETG100](#) [ST-4ETG101](#) [ST-4ETD201](#) [ST-4ETD202](#) [ST-4ETD203](#) [ST-4ETD204](#) [ST-4ETD205](#) [ST-4ETD500](#) [ST-4ETD101](#) [ST-4ETD102](#) [ST-4ETD103](#) [ST-4ETD104](#) [ST-4ETD105](#) [ST-4ETD200](#) [ST-4ETA205](#) [ST-4ETB105](#) [ST-4ETB205](#) [ST-4ETB500](#) [ST-4ETB504](#) [ST-4ETD100](#) [ST-4EH503](#) [ST-4EH504](#) [ST-4ETA100](#) [ST-4ETA200](#) [ST-4ETA201](#) [ST-4ETA204](#) [ST-4EH203](#) [ST-4EH204](#) [ST-4EH205](#) [ST-4EH500](#) [ST-4EH501](#) [ST-4EH502](#) [ST-4EH103](#) [ST-4EH104](#) [ST-4EH105](#) [ST-4EH200](#) [ST-4EH201](#) [ST-4EH202](#) [ST-4EG502](#)